

STEREO INTEGRATED AMPLIFIER

AX-700 / AX-700U

IMPORTANT NOTICE

This manual has been provided for the use of authorized Yamaha Retailers and their service personnel. It has been assumed that basic service procedures inherent to the industry, and more specifically Yamaha Products, are already known and understood by the users, and have therefore not been restated.

WARNING: Failure to follow appropriate service and safety procedures when servicing this product may result in personal injury, destruction of expensive components and failure of the product to perform as specified. For these reasons, we advise all Yamaha product owners that all service required should be performed by an authorized Yamaha Retailer or the appointed service representative.

IMPORTANT: The presentation or sale of this manual to any individual or firm does not constitute authorization, certification, recognition of any applicable technical capabilities, or establish a principle-agent relationship of any form.

The data provided is believed to be accurate and applicable to the unit(s) indicated on the cover. The research, engineering, and service departments of Yamaha are continually striving to improve Yamaha products. Modifications are, therefore, inevitable and specifications are subject to change without notice or obligation to retrofit. Should any discrepancy appear to exist, please contact the distributor's Service Division.

WARNING: Static discharges can destroy expensive components. Discharge any static electricity your body may have accumulated by grounding yourself to the ground buss in the unit (heavy gauge black wires connect to this buss).

IMPORTANT: Turn the unit OFF during disassembly and parts replacement. Recheck all work before you apply power to the unit.

AX-700/700U

CONTENTS

TO SERVICE PERSONNEL	1	ADJUSTMENTS	5
FRONT PANELS	1	BLOCK DIAGRAM	6
REAR PANELS	2	WIRING	7
SPECIFICATIONS	3	PRINTED CIRCUIT BOARD	8~11
INTERNAL VIEW	4	SCHEMATIC DIAGRAM	12
DISASSEMBLY PROCEDURES	4	PARTS LIST	13~20

100087

SINCE 1887



YAMAHA

NIPPON GAKKI CO., LTD. HAMAMATSU, JAPAN

3.3K-362 © Printed in Japan '87.3

TO SERVICE PERSONNEL

- Critical Components Information.**
Components having special characteristics are marked  and must be replaced with parts having specifications equal to those originally installed.
- Leakage Current Measurement (For 120V Model Only).**
When service has been completed, it is imperative that you verify that all exposed conductive surfaces are properly insulated from supply circuits.
 - Meter impedance should be equivalent to 1500 ohm shunted by 0.15μF.
 - Leakage current must not exceed 0.5mA.
 - Be sure to test for leakage with the AC plug in both polarities.
- POLARIZATION**

This tuner product is equipped with a polarized alternating-current line plug (a plug having one blade wider than the other). This plug will fit into the power outlet only one way. This is a safety feature. (U.C model only)

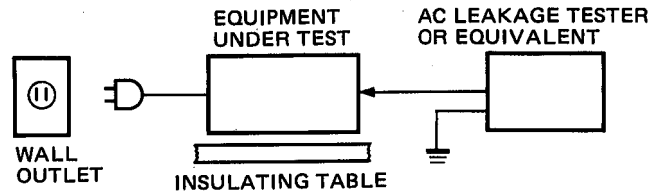

FRONT PANELS

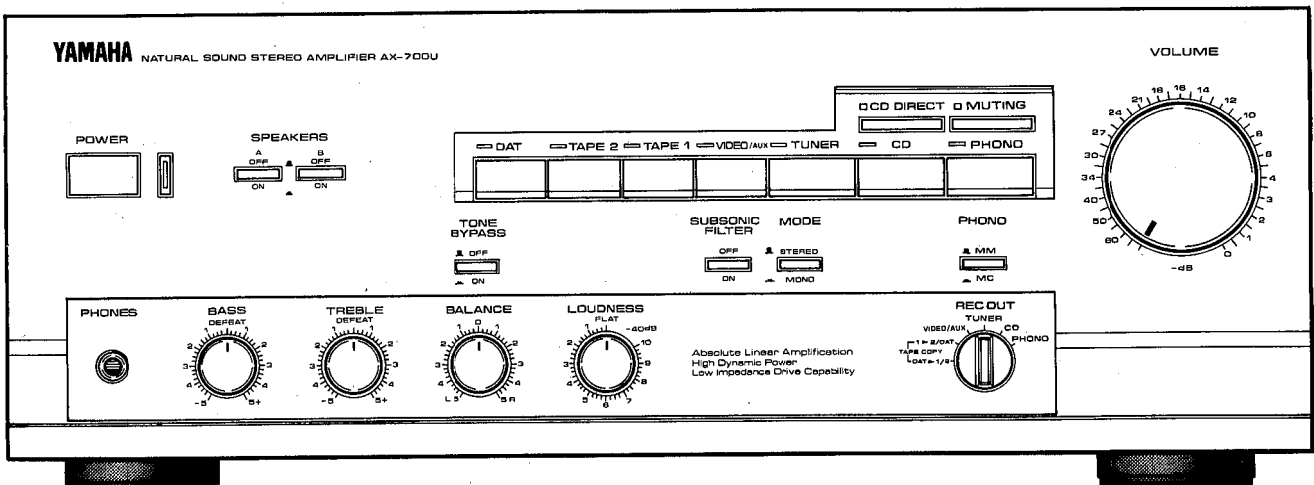
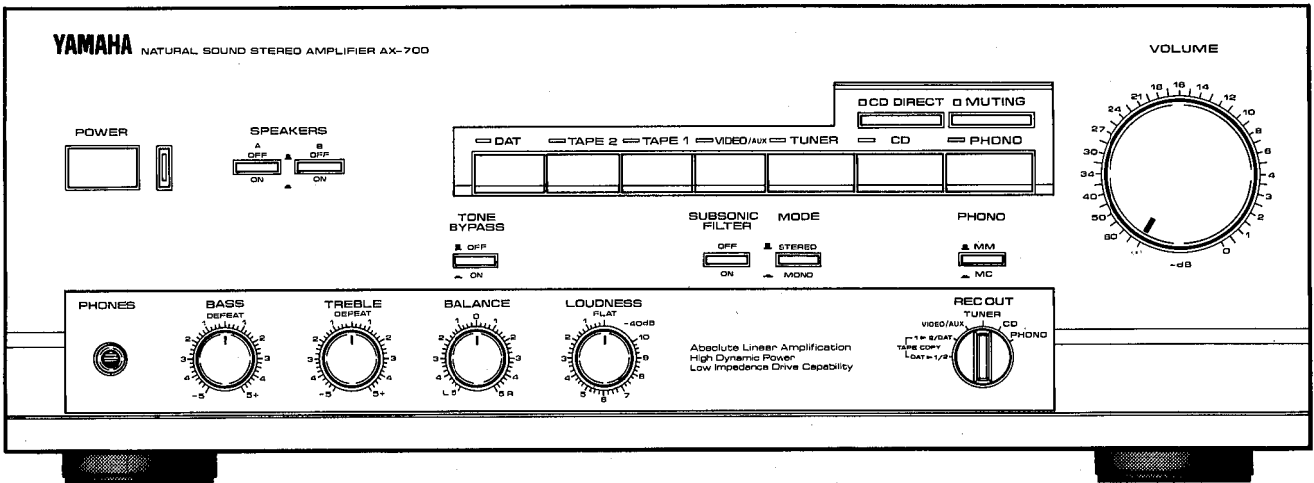

AX-700/700U

REAR PANELS

- U.S.A. & Canadian models

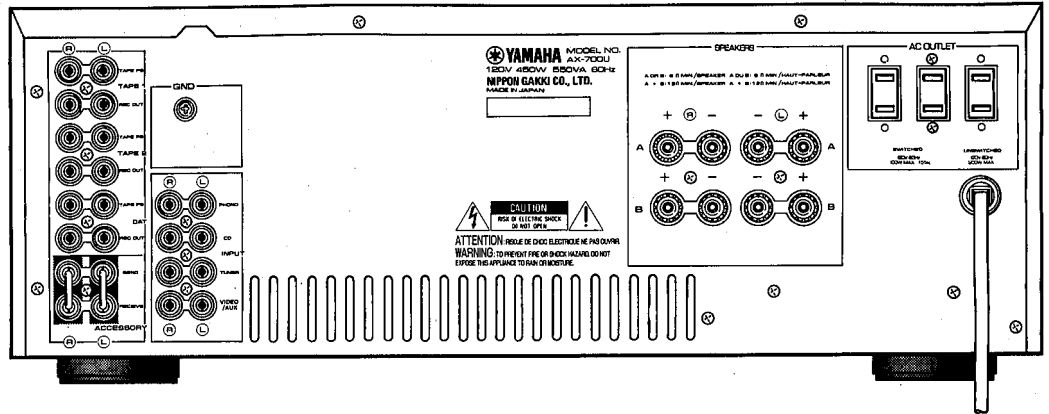

- European & British models

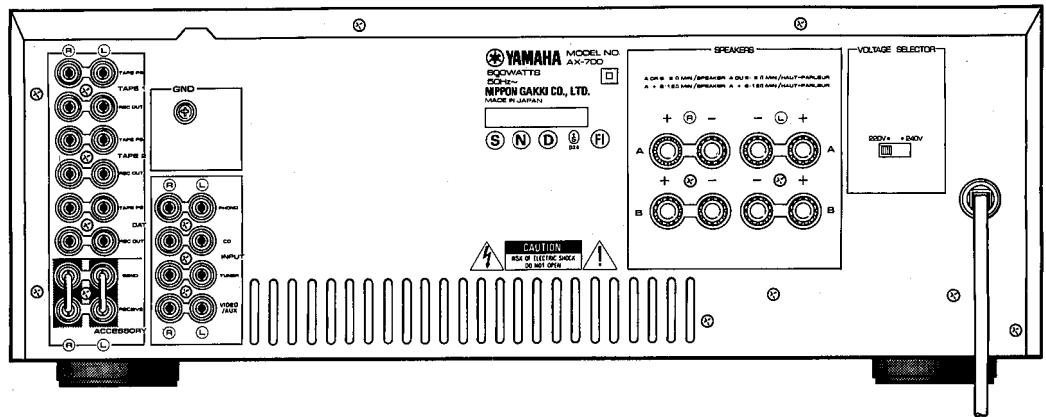

- Australian model

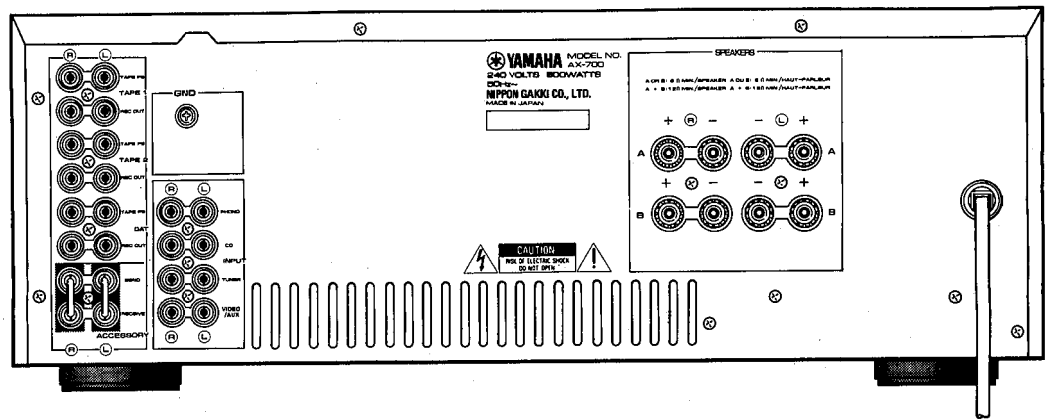

- General model

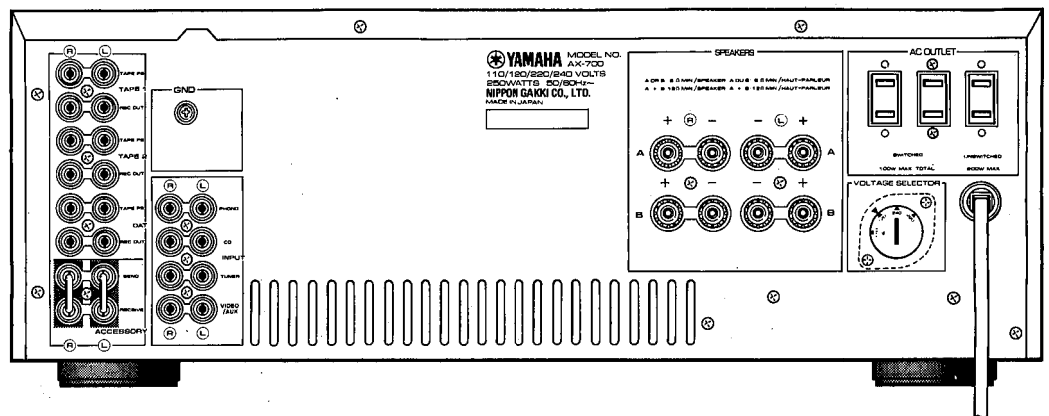

AX-700/700U

■ SPECIFICATIONS

■ AUDIO SECTION

Minimum RMS Output Power Per Channel	
20Hz~20kHz, 0.005% THD, 8Ω	110W (R)(U)(C) 110W (A)(G)(B)
0.008% THD, 6Ω	130W (R)(U)(C)
Dynamic Power Per Channel	
8Ω	160W
6Ω	210W
4Ω	280W
2Ω	350W
1Ω	400W
Power Band Width	
0.03%THD, 55W, 8Ω	10Hz~50kHz
IEC Power	
1kHz 0.01%THD8Ω	120W (A)(G)(B)
Damping Factor	
1kHz, 8Ω	100
Input Sensitivity/Impedance	
Phono MC	160μV/220Ω
Phono MM	2.5mV/47kΩ
CD/etc.	150mV/47kΩ
Input Sensitivity (New IHF)	
Phono MC	16μV
Phono MM	0.25mV
CD/etc.	15mV
Maximum Input Signal	
Phono, 1kHz, 0.01% THD (MC)	10mV
(MM)	160mV
Output Level/Impedance	
REC OUT	150mV/470Ω
Headphone Jack Rated Output/Impedance	
0.0x% THD (xxΩ)	0.85V/8Ω
Frequency Response	
20Hz~20kHz, CD/etc.	0± _{0.5} dB
RIAA Equalization Deviation	
20Hz~20kHz Phono MC	0±0.3dB
MM	0±0.2dB
20Hz~100kHz Phono MC	0±0.5dB
MM	
Total Harmonic Distortion (20Hz~20kHz)	
Phono MC to Rec Out 3V	0.006%
Phono MM to Rec Out 3V	0.003%
CD/etc. to SP Out 55W/8Ω	0.005%
Intermodulation Distortion	
CD/etc. to Rated Output/8Ω	0.002%
1W/8Ω	0.003%
Signal to Noise Ratio (IHF-A-Network)	
Phono	
MC (500μV Input Shorted)	76dB
MM (5mV Input Shorted)	92dB
CD/etc. (Input Shorted)	106dB
Signal to Noise Ratio (New IHF)	
Phono MC	75dB
MM	75dB
CD/etc.	86dB
Residual Noise (IHF-A-Network)	
(TONE BYPASS ON)	150μV
Channel Separation (Vol. -30dB)	
Phono Input Shorted, 1kHz	70dB
CD/etc. Input 5.1kΩ, 1kHz	65dB

Tone Control Characteristics

BASS boost/cut	0±10dB (at 20Hz)
turnover frequency	350Hz
TREBLE boost/cut	0±10dB (at 20kHz)
turnover frequency	3.5kHz

Filter Characteristics

Subsonic	15Hz (-12dB/oct.)
----------	-------------------

Continuous Loudness Control (Level related equalization)

Attenuation	-40dB (at 1kHz)
Audio Muting	-20dB

■ GENERAL

Power Supply

U.S. & Canadian Models	120VAC, 60Hz
European & British Models	220V/240VAC, 50Hz
Australian Model	240VAC, 50Hz
Others Model	110/120/220/ 240VAC 50/60Hz

Power Consumption

450W (U)
550VA (C)
250W (R)
600W (A,G,B)

AC Outlet

Switched x 1	100W Max (R)(U)(C)
Unswitched x 1	200W Max (R)(U)(C)

Dimensions (W x H x D)

435x165x416mm (17-1/8"x6-1/2"x16-3/8")

Weight

11.5kg (25 lbs 5 oz)

CD/etc.; CD/VIDEO/TUNER/AUX/TAPE/VCR

(U)	U.S.A. model
(C)	Canadian model
(A)	Australian model
(G)	European model
(B)	British model
(R)	General model

Specifications subject to change without notice.

INTERNAL VIEW

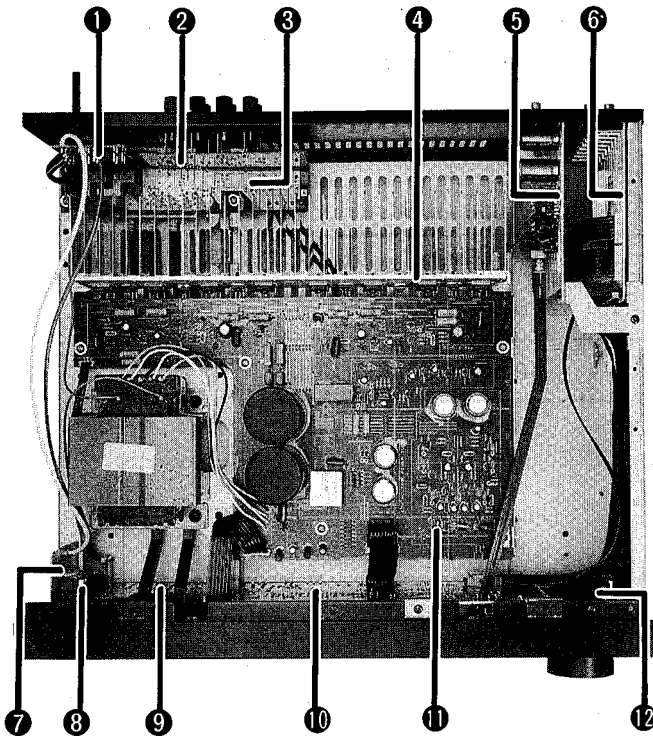

- ① Main Circuit Board (6)
- ② Main Circuit Board (4)
- ③ Main Circuit Board (3)
- ④ Radiator Unit
- ⑤ Function Circuit Board (1)
- ⑥ Function Circuit Board (2)
- ⑦ Main Circuit Board (7)
- ⑧ Main Circuit Board (5)
- ⑨ Main Circuit Board (2)
- ⑩ Function Circuit Board (3)
- ⑪ Main Circuit Board (1)
- ⑫ Function Circuit Board (4)

DISASSEMBLY PROCEDURES

(Remove parts in disassembly order as numbered)

1. Removal of Top Cover

Remove 6 screws (①) in Fig. 1, and slide the Top Cover back.

2. Removal of Front Panel

Remove 6 screws (②, ③) in Fig. 1. and pull the Front Panel forward.

3. Removal of Bottom Cover

Remove 9 screws (③, ④) in Fig. 1.

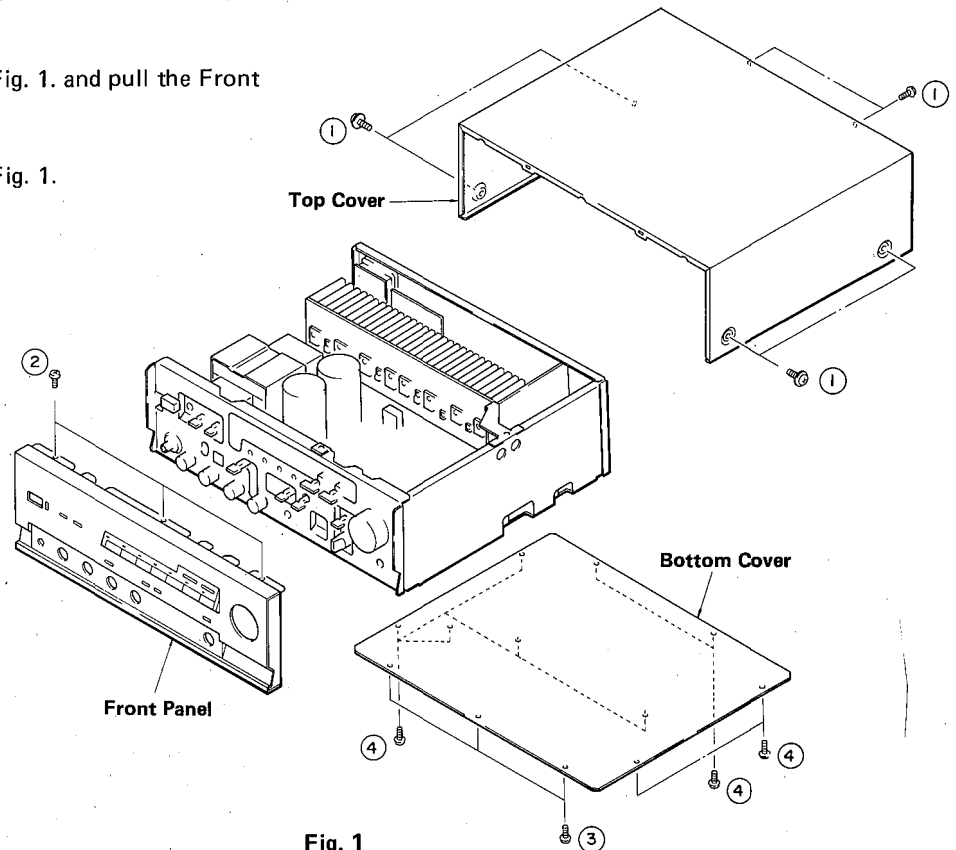

Fig. 1

■ ADJUSTMENTS

● IDLING CURRENT ADJUSTMENT

When replacing the power and drive transistors, adjust idling current.

After the power has been turned on, age about 2 minutes in non loaded condition.

Adjust VR301 (Lch) and VR302 (Rch) so that the voltage across the terminals of R381, 383, 385 or 387 and R382, 384, 386 or 388 comes to 10mV±2mV DC.

	Test Points	Adjustment Points	Rating
Lch	Across the terminals of R381, 383, 385 or 387	VR301	10 mV±2 mV DC
Rch	Across the terminals of R382, 384, 386 or 388	VR302	10 mV±2 mV DC

MAIN P.C (1)

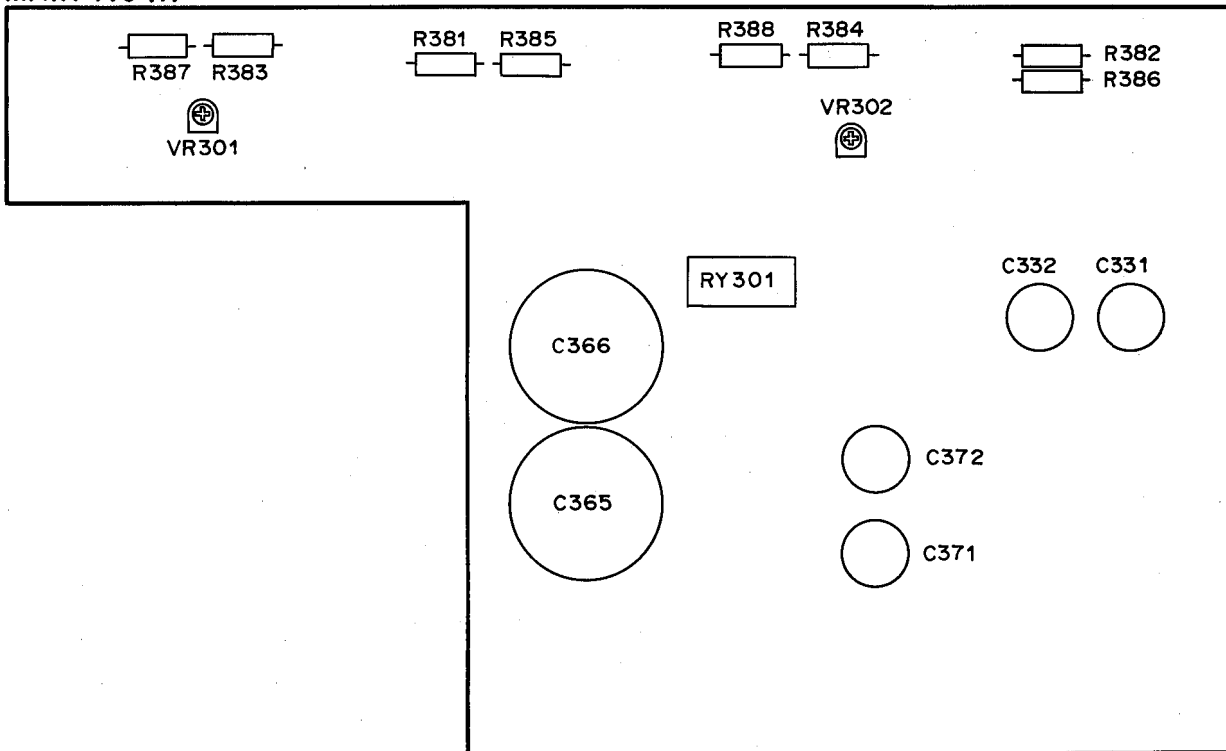

■ BLOCK DIAGRAM

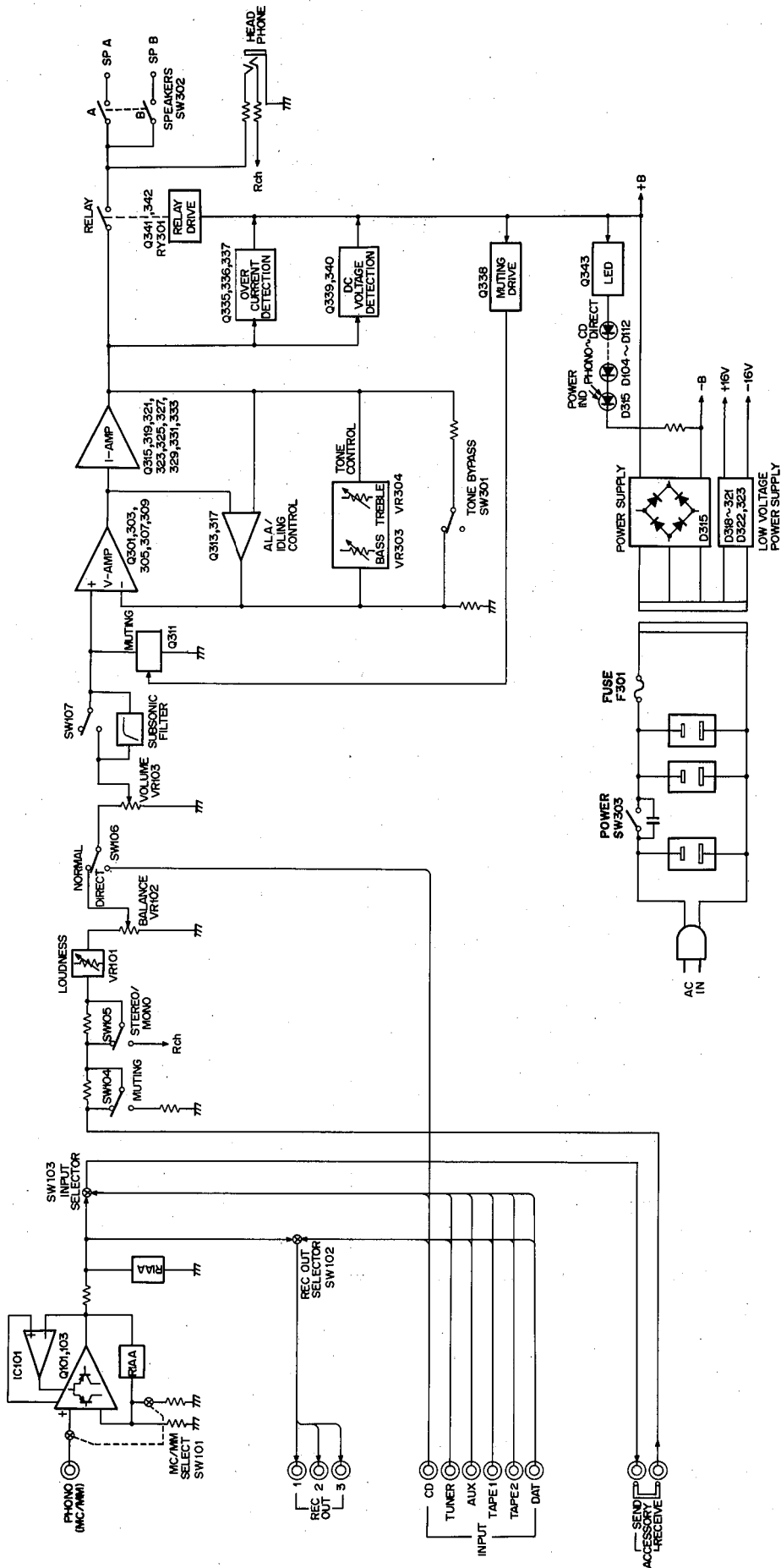

AX-700/700U

WIRING

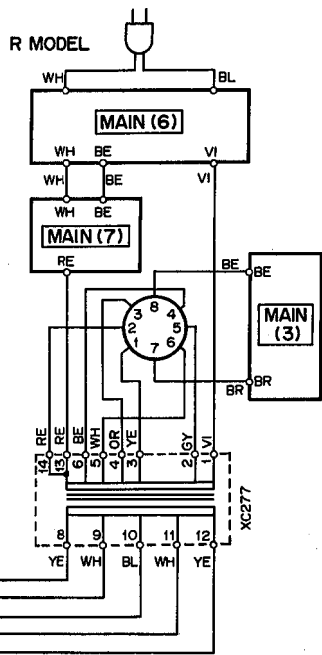
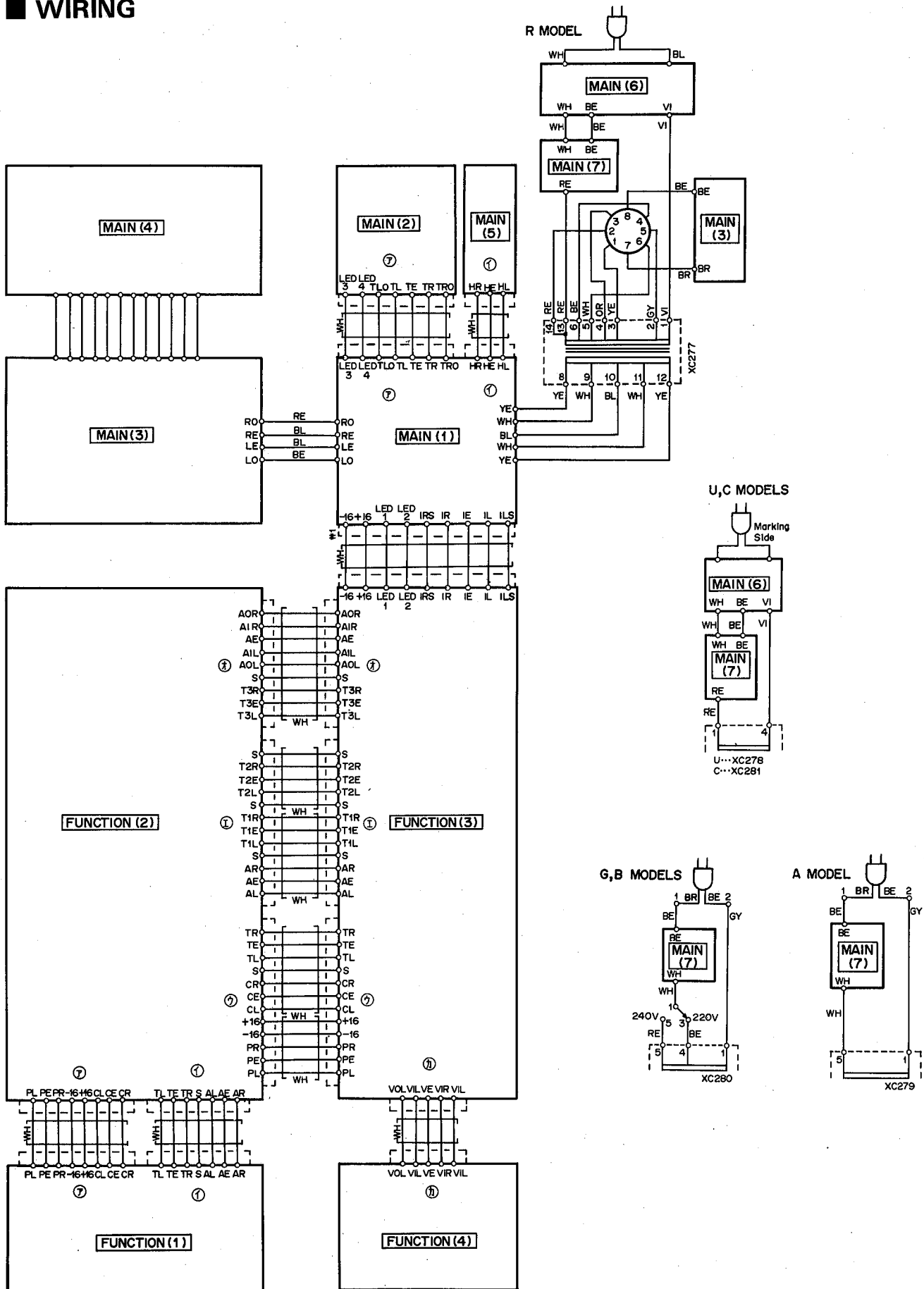

U,C MODELS

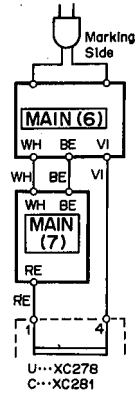

G,B MODELS

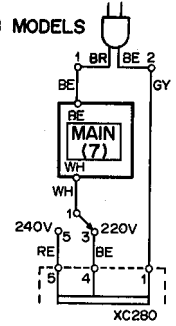

A MODEL

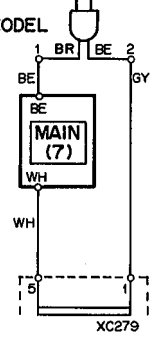

AX-700/700U

■ WARNING

PARTS LIST

■ ELECTRICAL PARTS

Components having special characteristics are marked  and must be replaced with parts having specifications equal to those originally installed. Carbon resistors 1/4 W are not included in the ELECTRICAL PARTS list. For the parts No. of the carbon resistor, refer to P. 27.

Ref. No.	Part No.	Description	部 品 名	Remarks	Common Model	Markets	ランク
	NA 09 42 80	Main Circuit Board	メ イ ン シ ー ト			R	
	NA 09 42 90	"	"			U,C	
	NA 09 43 00	"	"			A	
	NA 09 43 10	"	"			G,B	
	FC 44 44 70	Mylar Cap. 0.047μF 50V	マ イ ラ ー コ ン	C349, 350			
	Fi 38 41 00	Ceramic Cap. 0.01μF VA-1	セ ラ コ ン	C374 Inter-			
	Fi 50 41 00	" 0.01μF DNS	"	" changeable			
	FG 21 05 00	" 5pF 50V	"	C313, 314			
	FG 71 11 00	" 10pF 50V	"	C335, 336			
	FG 21 13 90	" 39pF 50V	"	C343, 344			
	FG 21 21 50	" 150pF 50V	"	C377, 378		A,G,B	
	FG 21 22 20	" 220pF 50V	"	C323, 324			
	FU 35 12 20	Mica Cap. 22pF 500V	マ イ カ コ ン	C339~342			
*	VC 69 22 00	Electrolytic Cap. 18000μF 71V	ケ ミ コ ン	C365, 366			
	FZ 00 46 60	MM Cap. 0.1μF 250V	M M コ ン	C367			
	FZ 00 46 60	" 0.1μF 250V	"	C370		R,U,C	
	FZ 00 46 60	" 0.1μF 250V	"	C361, 368, 369, 373		A,G,B	
	FZ 00 46 80	Electrolytic Cap. 680μF 80V	ケ ミ コ ン	C331, 332			
	FZ 00 74 10	" 1000μF 25V	ブ ラ ッ ク ゲ ー ト コ ン	C371, 372			
	FZ 00 54 10	" 100μF 6.3V	"	C337, 338			
	FZ 00 61 30	" 220μF 6.3V	"	C311, 312			
	FA 15 31 20	Mylar Cap. 1200pF 50V	マ イ ラ ー コ ン	C325, 326			
	FA 15 32 20	" 2200pF 50V	"	C309, 310			
	FA 15 35 60	" 5600pF 50V	"	C327, 328			
	FA 15 41 00	" 0.01μF 50V	"	C353~358		A,G,B	
	FA 15 42 70	" 0.027μF 50V	"	C329, 330			
	FA 15 43 90	" 0.039μF 50V	"	C319, 320			
	FA 15 51 20	" 0.12μF 50V	"	C321, 322			
	UJ 11 81 00	Electrolytic Cap. 100μF 6.3V	ケ ミ コ ン	C315~318			
	FJ 14 82 20	" 220μF 6.3V	"	C364			
	UW 83 71 00	" 10μF 16V	"	C305, 306			
	UW 83 72 20	" 22μF 16V	"	C363			
	UJ 13 74 70	" 47μF 16V	"	C303, 304			
	UJ 13 81 00	" 100μF 16V	"	C345, 346, 362			
	UW 84 71 00	" 10μF 25V	"	C375			
	UJ 15 82 20	" 220μF 35V	"	C333, 334			
	UW 56 53 30	" 0.33μF 50V	"	C359			
	UJ 16 64 70	" 4.7μF 50V	"	C360			
	UT 45 44 70	Polypropylene Film Cap. 0.047μF 100V	ポ リ プ ロ コ ン	C347, 348, 351, 352			
	UT 45 22 20	" 220pF 100V	"	C301, 302, 307, 308			
	VC 79 37 00	Coil 1.5μH	空 心 コ イ ル	L301, 302			
	HV 45 52 20	Flame Proof Carbon Resistor 220Ω 1/4W	不 燃 化 カ ー ボ ン 抵 抗	R317~320			
	HV 45 31 00	" 1Ω 1/4W	"	R435, 436			
	HV 45 34 70	" 4.7Ω 1/4W	"	R377~380 391, 392, 432, 443, 444			
	HV 45 41 00	" 10Ω 1/4W	"	R399, 400			
	HV 45 42 20	" 22Ω 1/4W	"	R365, 366			
	HV 45 51 00	" 100Ω 1/4W	"	R363, 364, 375, 376			
	HV 45 51 80	" 180Ω 1/4W	"	R321, 322			
	HV 45 55 60	" 560Ω 1/4W	"	R361, 362			
	HV 45 61 00	" 1kΩ 1/4W	"	R353~356			

※ New Parts (新規部品)

AX-700/700U

AX-700/700U

Ref. No.	Part No.	Description	部 品 名	Remarks	Common Model	Markets	ランク
	HV 45 61 20	Flame Proof Carbon Resistor	1. 2kΩ 1/4W	不燃化カーボン抵抗	R371~374, 393, 394		
	HV 45 62 20	"	2. 2kΩ 1/4W	"	R357, 358, 367~370		
	HV 45 65 60	"	5. 6kΩ 1/4W	"	R389, 390		
	HL 31 44 70	Metal Oxide Film Resistor	47Ω 1W	酸 金 抵 抗	R433, 434		
	HL 32 34 70	"	4. 7Ω 2W	"	R445, 446		
	HL 32 52 70	"	270Ω 2W	"	R397, 398		
	HL 42 63 30	"	3. 3kΩ 2W	"	R426, 427		
※	HL 93 22 20	"	0. 22Ω 3W	"	R381~388		
	VA 78 76 00	Pre-Set Potentiometer	B1kΩ	半 固 定 抵 抗 器	VR301, 302		
	VB 14 07 00	"	B1kΩ	"	"		
※	VC 23 68 00	Potentiometer	40kΩ×2	可 変 抵 抗 器	VR303 BASS		
※	VC 23 69 00	"	100kΩ×2	"	VR304 TREBLE		
	iA 09 70 00	Transistor	2SA970(GR, BL)	ト ラ ン ジ ス タ ー	Q301~304, 321, 322 337, 343		
	iA 10 15 21	"	2SA1015(Y)	"	Q313, 314		
	iC 18 15 20	"	2SC1815(Y)	"	Q307, 308, 342		
	iC 22 40 00	"	2SC2240(GR, BL)	"	Q305, 306, 317~320 335, 336, 338~341		
	iC 27 05 00	"	2SC2705(O, Y)	"	Q309, 310		
	iX 60 42 00	"	2SC2878(A, B)	"	Q311, 312		
	iF 00 06 70	Diode	1S2473	ダ イ オ ード	D301~308 311~313 Inter-		
	iF 00 00 40	"	1S1555	"	" changeable		
	iF 00 14 00	"	1SS82	"	D309, 310, 317		
	iF 00 19 40	Zener Diode	HZ24-2	ツェナーダイオード	D314		
	iF 00 20 80	"	HZ16-3L	"	D322, 323		
	iF 00 42 70	LED	SLR-55URC3H	L E D	D315		
	iH 00 11 60	Diode, Bridge	4D4B41	ダイオードブリッジ	D316		
	iF 00 84 80	Diode	1SR35-100A	ダ イ オ ード	D318~321		
	KA 80 35 70	Push Switch	2-2NS	プッシュスイッチ	SW302 Speaker		
※	VC 23 49 00	Power Switch	TV-5	パワースイッチ	SW303 Power		
※	VC 37 81 00	Push Switch	2-2S	プッシュスイッチ	SW301 Tone Bypass		
	KB 00 04 00	Fuse	T5. 0A 250V	ヒューズタイラッシュ	F302		R
	KB 00 07 90	"	T4. 0A 250V	ヒューズタイムラグ	F301		A, G, B
※	KB 00 13 90	"	10A 250V	U L ヒューズ	"		U, C
	KB 00 14 90	"	10A 250V	ヒューズ	"		R
	VC 27 86 00	Relay	G5R-2232PDC24V	リ レ ー	RY301		
	KC 00 19 40	"	DH24D2-OTM	"	" Inter-		
	KC 00 20 00	"	JR2A-DC24V	"	" changeable		
	LB 30 17 20	Jack		ホ ー ン ジャック	JK301		
※	VD 26 28 00	Slide SW Ass'y		スライドスイッチ Ass'y	Voltage Selector		G, B
	LA 00 21 40	Lapping Terminal	P=10 i-Type	i 型ラッピング端子板			
※	VC 31 36 00	Speakers Terminal	8P	スピーカーターミナル			R, U, A, C
※	VC 72 08 00	"	8P	"			G, B

※New Parts (新規部品)

AX-700/700U

Ref. No.	Part No.	Description	部品名	Remarks	Common Model	Markets	ランク
	LB 20 10 60	Fuse Holder Pin	YSH403T	ヒューズホルダーピン		A,G,B	
	LB 20 19 70	"	23165081	"		R,U,C	
	LB 60 42 80	AC Outlet	3P	A C アウトレット		R	
	LB 60 81 70	"	3P	"		U,C	
	CB 64 46 70	Cover, Capacitor		コンデンサーカバー		G,B	
	VA 72 53 00	Parallel Holder	3P	バラレルホルダー			
	VA 72 57 00	"	7P	"			
	VB 23 00 00	Wire Trap	9P	ワイヤートラップ			
	BB 06 95 10	GND Metal		ランド金具			
	VA 82 15 00	Radiator		ラジエター		U,C	
	EZ 00 13 50	Cup Tight Screw	3X14 FCRM3-BI	カップタイトネジ		U,C	
	NA 09 43 20	Function Circuit Board		ファンクションシート		R,U,A,C	
	NA 09 43 30	"		"		G,B	
	FZ 00 65 40	Mylar Cap.	0.01μF 50V	マイラーコン	C105,106		
	FG 21 22 20	Ceramic Cap.	220pF 50V	セラコン	C127~138, 145~148	G,B	
	FG 41 24 70	"	470pF 50V	"	C139~144, 162, 163	G,B	
	FG 24 41 00	"	0.01μF 50V	"	C161	G,B	
※	VC 78 07 00	Electrolytic Cap.	1000μF 25V	ケミコン	C125,126		
※	UA 25 24 70	Mylar Cap.	470pF 50V	マイラーコン	C153,154		
	UA 25 31 50	"	1500pF 50V	"	C111,112	R,U,A,C	
	FA 15 32 70	"	2700pF 50V	"	"	G,B	
	UA 25 35 60	"	5600pF 50V	"	C123,124		
	FA 15 41 80	"	0.018μF 50V	"	C121,122		
	UA 25 43 30	"	0.033μF 50V	"	C149,150		
	UA 25 44 70	"	0.047μF 50V	"	C155~158		
	UI 33 71 00	Electrolytic Cap.	10μF 16V	ケミコン	C107,108,159,160		
	UW 56 53 30	"	0.33μF 50V	"	C151,152		
	UI 91 92 20	"	2200μF 6.3V	"	C113,114		
	UK 13 72 20	"	22μF 16V	B P ケミコン	C119,120		
	UT 46 41 10	Polypropylene Film Cap.	0.011μF 100V	ポリプロコン	C117,118		
	UT 46 43 90	"	0.039μF 100V	"	C115,116		
	UT 45 22 20	"	220pF 100V	"	C109,110		
	UT 45 21 50	"	150pF 100V	"	C101,102	G,B	
	VA 98 35 00	Coil	15μH	コイル	L101,102	G,B	
※	VC 40 73 00	"	470μH	"	L103,104	G,B	
	HF 85 41 00	Carbon Film Resistor	10Ω 1/6W	カーボン抵抗	R127,128		
	HF 85 34 70	"	4.7Ω 1/6W	"	R181	G,B	
	HF 85 42 20	"	22Ω 1/6W	"	R173,174	G,B	
	HF 85 43 30	"	33Ω 1/6W	"	R105,106	R,U,A,C	
	HF 85 64 70	"	4.7kΩ 1/6W	"	"	G,B	
	HF 85 51 00	"	100Ω 1/6W	"	R119,120	R,U,A,C	
	HF 85 51 80	"	180Ω 1/6W	"	R119,120	G,B	
	HF 85 51 50	"	150Ω 1/6W	"	R121,122,129,130		

※New Parts (新規部品)

Ref. No.	Part No.	Description	部品名	Remarks	Common Model	Markets	ランク
	HF 85 52 20	Carbon Film Resistor	220Ω 1/6W	カーボン抵抗	R141~156, 175~180, 183, 184	G,B	
	HF 85 52 20	"	220Ω 1/6W	"	R107,108		
	HF 85 54 70	"	470Ω 1/6W	"	R131,132,165,166		
	HF 85 61 00	"	1kΩ 1/6W	"	R169,170		
	HF 85 61 20	"	1.2kΩ 1/6W	"	R137		
	HF 85 64 70	"	4.7kΩ 1/6W	"	R113,114,159~162		
	HF 85 65 60	"	5.6kΩ 1/6W	"	R167,168		
	HF 85 66 80	"	6.8kΩ 1/6W	"	R115~118, 123, 124		
	HF 85 71 80	"	18kΩ 1/6W	"	R135,136		
	HF 85 74 70	"	47kΩ 1/6W	"	R157,158		
	HF 85 76 80	"	68kΩ 1/6W	"	R163,164		
	HF 85 78 20	"	82kΩ 1/6W	"	R111,112,125,126		
	HF 85 81 20	"	120kΩ 1/6W	"	R109,110		
	HF 85 81 50	"	150kΩ 1/6W	"	R133,134		
	HF 85 92 20	"	2.2MΩ 1/6W	"	R171,172		
	HL 32 41 00	Metal Oxide Film Resistor	10Ω 2W	酸化金抵抗	R101,102		
	HV 45 51 00	Flame Proof Carbon Resistor	100Ω 1/4W	不燃化カーボン抵抗	R139,140		
※	VC 23 66 00	Potentiometer	250kΩ MN	可変抵抗器	VR102 BALANCE		
※	VC 23 67 00	"	300kΩ X2	"	VR101 LOUDNESS		
※	VC 36 98 00	"	60kΩ (Y)X2	"	VR103 VOLUME		
	IA 09 70 00	Transistor	2SA970(GR,BL)	トランジスター	Q101~104		
	IF 00 34 50	Diode	1SS133	ダイオード	D101,102		
	IX 60 80 20	Zener Diode	MTZ 6.2B	ツェナーダイオード	D103		
	IF 00 87 30	LED	SLR-34URC3H3	L E D	D104~112		
	IG 09 20 00	IC	M5220L	I C	IC101		
※	VC 78 11 00	Remote Switch		リモートスイッチ	SW102 REC OUT		
※	VC 17 67 00	Push Switch	4-2NS	プッシュスイッチ	SW104,105 Muting/CD Direct		
※	VC 23 56 00	"	7	"	SW103 Input Selector		
※	VC 23 61 00	"	2-2S	"	SW107 Subsonic Filter		
※	VC 24 55 00	"	2-2NS	"	SW105 Mode		
※	VC 36 99 00	"	6-2	"	SW101 Phono		
	LB 20 22 90	Pin Jack	2P	ピンジャック	PJ101		
	LB 40 10 30	"	4P	"	PJ103~106		
	LB 60 60 90	"	6P	"	PJ102		
	VA 72 55 00	Parallel Holder	5P	バラレルホルダー			
	VA 72 57 00	"	7P	"			
	VA 72 58 00	"	8P	"			
	VA 72 59 00	"	9P	"			
	VA 72 62 00	"	12P	"			

※New Parts (新規部品)

AX-700/700U

MECHANISM EXPLODED VIEW

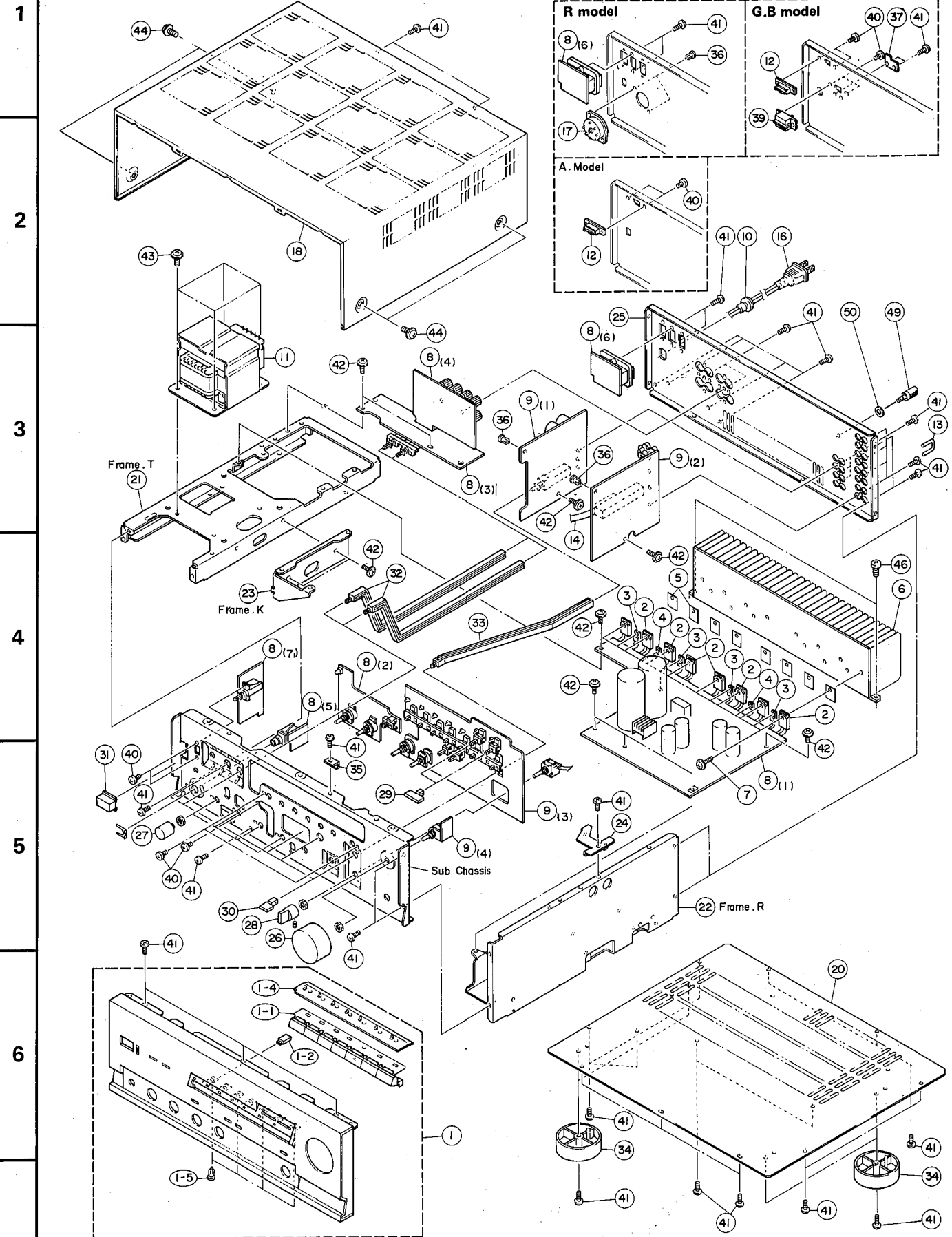

MECHANISM PARTS

Ref. No.	Part No.	Description	部品名	Remarks	Common Model	Markets	ランク
※ 1	VD 09 48 00	Panel Unit	パネルユニット	Silver		R,A,G,B	
※ "	VD 09 49 00	"	"	Silver		U,C	
※ "	VD 09 50 00	"	"	Black		R,A,G,B	
※ "	VD 09 51 00	"	"	Black		U,C	
1-1	NB 63 99 90	Button Ass'y	ボタン Ass'y	Silver			
"	NB 64 00 00	"	"	Black			
1-2	CB 66 07 40	Lens	レンズ				
1-3	CB 66 07 50	Lens	レンズ				
1-4	AA 63 17 10	Frame SW	フレーム S W				
1-5	CB 60 56 20	Plastic Rivet	プラスチックリベット				
2	IX 60 91 90	Pair Transistor	ペアトランジスタ	Q329, 330, 333, 334			
"	IX 60 92 00	"	"	Q327, 328, 331, 332			
3	IX 60 81 50	Pair Transistor	ペアトランジスタ	Q325, 326			
"	IX 60 81 60	"	"	Q323, 324			
4	VC 39 81 00	Transistor	トランジスタ	Q315, 316			
5	VB 43 50 00	Insulation Base	放熱シート				
6	BA 09 67 30	Radiator	ラジエター				
7	EX 60 02 50	Cup Screw	3×10 FCM3-BI カップタイトネジ				
※ 8	NA 09 42 80	Main Circuit Board	メインシート			R	
※ "	NA 09 42 90	"	"			U,C	
※ "	NA 09 43 00	"	"			A	
※ "	NA 09 43 10	"	"			G,B	
※ 9	NA 09 43 20	Function Circuit Board	ファンクションシート			R,U,A,C	
※ "	NA 09 43 30	"	"			G,B	
10	CB 62 01 90	Cord Stopper	CM-22B コードストッパー			R,A,G,B	
"	CB 62 02 00	"	CM-22C			U,C	
※ 11	XC 27 70 01	Power Transformer	電源トランス			R	
※ "	XC 27 80 01	"	"			U	
※ "	XC 27 90 01	"	"			A	
※ "	XC 28 00 01	"	"			G,B	
※ "	XC 28 10 01	"	"			C	
12	LA 00 29 50	Terminal Board	2P 中継端子台			A,G,B	
13	LB 10 11 10	Short Plug	ショートプラグ				
※ 14	VC 40 03 00	Wire, Remote SW	リモートSWワイヤー部				
16	MG 00 16 20	Power Cord	2.5A 250V 2m 電源コード	Inter changeable		G	
"	MG 00 23 20	"	2.5A 250V 2m	"		"	
"	MG 00 16 30	"	6A 250V 2m	"		R	
"	MG 00 09 20	"	7.5A 250V 2.5m	Inter changeable		A	
"	MG 00 23 10	"	7.5A 250V 2m	"		"	
"	MG 00 22 20	"	10A 125V1.98m	"		U,C	
"	MG 00 18 60	"	2.5A 250V 2m	"		B	
17	LB 20 14 80	Voltage Selector	電圧切換器				
39	KA 40 12 60	Slide Switch	5A/40A SS-12 スライドスイッチ	VOLTAGE SELECTOR			
18	AA 63 16 30	Top Cover	トップカバー	Silver			
19	AA 63 16 40	"	"	Black			
20	AA 63 16 20	Bottom Cover	ボトムカバー				
21	AA 63 16 00	Frame T	フレーム (T)				
22	AA 63 16 10	Frame R	フレーム (R)				
23	AA 63 17 30	Frame K	フレーム (K)				
24	AA 63 22 60	Support Sheet	サポートシート				
※ 25	AA 63 22 70	Rear Panel	リヤパネル			R	
※ "	AA 63 22 80	"	"			U,C	

※ New Parts (新規部品)

Ref. No.	Part No.	Description	部 品 名	Remarks	Common Model	Markets	ランク
※	AA 63 22 90	Rear Panel	リ ヤ バ ネ ル			G,B	
※	AA 63 23 00	"	"			A	
	26 BA 09 24 30	Knob (R) Ø48	ノ ブ	Silver VOLUME			
	BA 09 65 40	" Ø48	"	Black "			
	27 BA 09 59 20	Knob Ø18	"	Silver BASS, TREBLE, BALANCE, LOUDNESS			
	BA 09 65 70	" Ø18	"	Black "			
	28 BA 09 59 00	Knob, Switch	ス イ ッ チ ノ ブ	Silver REC OUT			
	BA 09 65 60	"	"	Black "			
	29 CB 66 07 60	Button	ボ タ ン	Silver CDDIRECT, MUTING			
	CB 66 07 70	"	"	Black "			
	30 CB 66 07 80	"	"	Silver SPEAKERS			
	CB 66 07 90	"	"	Black "			
	31 CB 66 08 00	Button, Power	パ ワ ー ボ タ ン	Silver POWER			
	CB 66 08 10	"	"	Black "			
	32 CB 66 08 80	Rod, SP	ロ ッ ド				
	33 CB 66 08 90	Rod, EQ	"				
	34 CB 66 09 50	Leg	脚				
※	35 AA 63 24 60	Sheet, Stopper	ス ト ッ パ ー シ ー ト				
	36 CB 06 88 80	Plastic Rivet	プ ラ ス チ ッ ク リ ベ ッ ト				
	37 CB 60 14 40	VS Stopper	V S ス ト ッ パ ー				
※	38 CB 66 24 40	Cushion, Cap	ケ ミ コ ン ク ッ シ ョ ン				
	40 ED 33 00 66	Binding Head Screw 3X6 FCRM3-BI	バ イ ン ド 小 ネ ジ	PACK			
	41 EI 33 00 86	Binding Head Tapping Screw 3X8 FCRM3-BI	バ イ ン ド タ ッ ピ ン グ ネ ジ				
	42 EK 33 60 10	BW Head Tapping Screw 3X8-8FCRM3-BI	B W ヘ ッ ド タ ッ ピ ン グ ネ ジ				
	43 EK 96 60 70	" 4X8 FCRM3-BI	"				
	44 EK 13 00 20	" 4X8 FNM3-3g	"	Silver			
	45 EK 36 50 90	" 4X8 FCRM3-BI	"	Black			
	46 EA 34 00 86	Pan Head Screw 4X8 FCRM3-BI	ナ ベ 小 ネ ジ	PACK			
	47 EI 33 00 86	Binding Head Tapping Screw 3X8 FCRM3-BI	バ イ ン ド タ ッ ピ ン グ ネ ジ	PACK			
	49 AA 62 73 10	GND Terminal 3X13 STG	G N D タ ー ミ ナ ル	PACK			
	50 EV 20 13 66	Washer 3.6XØ10X0.8BNM3-3g	平 座 金	PACK			
	CB 06 92 50	Binding Tie	イ ン シ ュ ロ ッ ク タイ				

※New Parts (新規部品)

Parts List for Carbon Resistor

Value	1/4W Type Part No.	1/6W Type Part No.	Value	1/4W Type Part No.	1/6W Type Part No.
1.0 Ω	HJ353100	※	12K Ω	HJ357120	HF857120
1.8 "	HJ353180	※	15 "	HJ357150	HF857150
2.2 "	HJ353220	HF853220	18 "	HJ357180	HF857180
3.3 "	HJ353330	HF853330	22 "	HJ357220	HF857220
4.7 "	HJ353470	HF853470	27 "	HJ357270	HF857270
5.6 "	HJ353560	HF853560	33 "	HJ357330	HF857330
10 "	HJ354100	HF854100	39 "	HJ357390	HF857390
15 "	HJ354150	HF854150	47 "	HJ357470	HF857470
22 "	HJ354220	HF854220	56 "	HJ357560	HF857560
27 "	HJ354270	HF854270	68 "	HJ357680	HF857680
33 "	HJ354330	HF854330	82 "	HJ357820	HF857820
39 "	HJ354390	HF854390	91 "	HJ357910	HF857910
47 "	HJ354470	HF854470	100 "	HJ358100	HF858100
56 "	HJ354560	HF854560	120 "	HJ358120	HF858120
68 "	HJ354680	HF854680	150 "	HJ358150	HF858150
82 "	HJ354820	HF854820	180 "	HJ358180	HF858180
100 "	HJ355100	HF855100	220 "	HJ358220	HF858220
110 "	HJ355110	HF855110	270 "	HJ358270	HF858270
120 "	HJ355120	HF855120	330 "	HJ358330	HF858330
150 "	HJ355150	HF855150	390 "	HJ358390	HF858390
160 "	HJ355160	※	470 "	HJ358470	HF858470
180 "	HJ355180	HF855180	560 "	HJ358560	HF858560
220 "	HJ355220	HF855220	680 "	HJ358680	HF858680
270 "	HJ355270	HF855270	820 "	HJ358820	HF858820
330 "	HJ355330	HF855330	1.0M Ω	HJ359100	HF859100
390 "	HJ355390	HF855390	1.2 "	HJ359120	※
470 "	HJ355470	HF855470	1.5 "	HJ359150	HF859150
510 "	※	HF855510	1.8 "	HJ359180	HF859180
560 "	HJ355560	HF855560	2.2 "	HJ359220	HF859220
680 "	HJ355680	HF855680	3.3 "	HJ359330	HF859330
820 "	HJ355820	HF855820	3.9 "	HJ359390	※
910 "	HJ355910	HF855910	4.7 "	HJ359470	※
1.0K Ω	HJ356100	HF856100			
1.2 "	HJ356120	HF856120			
1.5 "	HJ356150	HF856150			
1.8 "	HJ356180	HF856180			
2.0 "	HJ356200	HF856200			
2.2 "	HJ356220	HF856220			
2.4 "	HJ356240	HF856240			
2.7 "	HJ356270	HF856270			
3.0 "	HJ356300	HF856300			
3.3 "	HJ356330	HF856330			
3.6 "	HJ356360	HF856360			
3.9 "	HJ356390	HF856390			
4.7 "	HJ356470	HF856470			
5.1 "	HJ356510	HF856510			
5.6 "	HJ356560	HF856560			
6.8 "	HJ356680	HF856680			
8.2 "	HJ356820	HF856820			
9.1 "	HJ356910	HF856910			
10 "	HJ357100	HF857100			

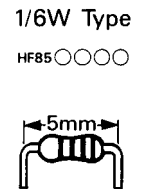
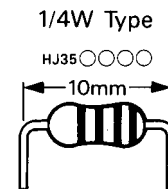

AX-700/700U

■ PRINTED CIRCUIT BOARD (Pattern Side) (Note) 文字面 : Component Side

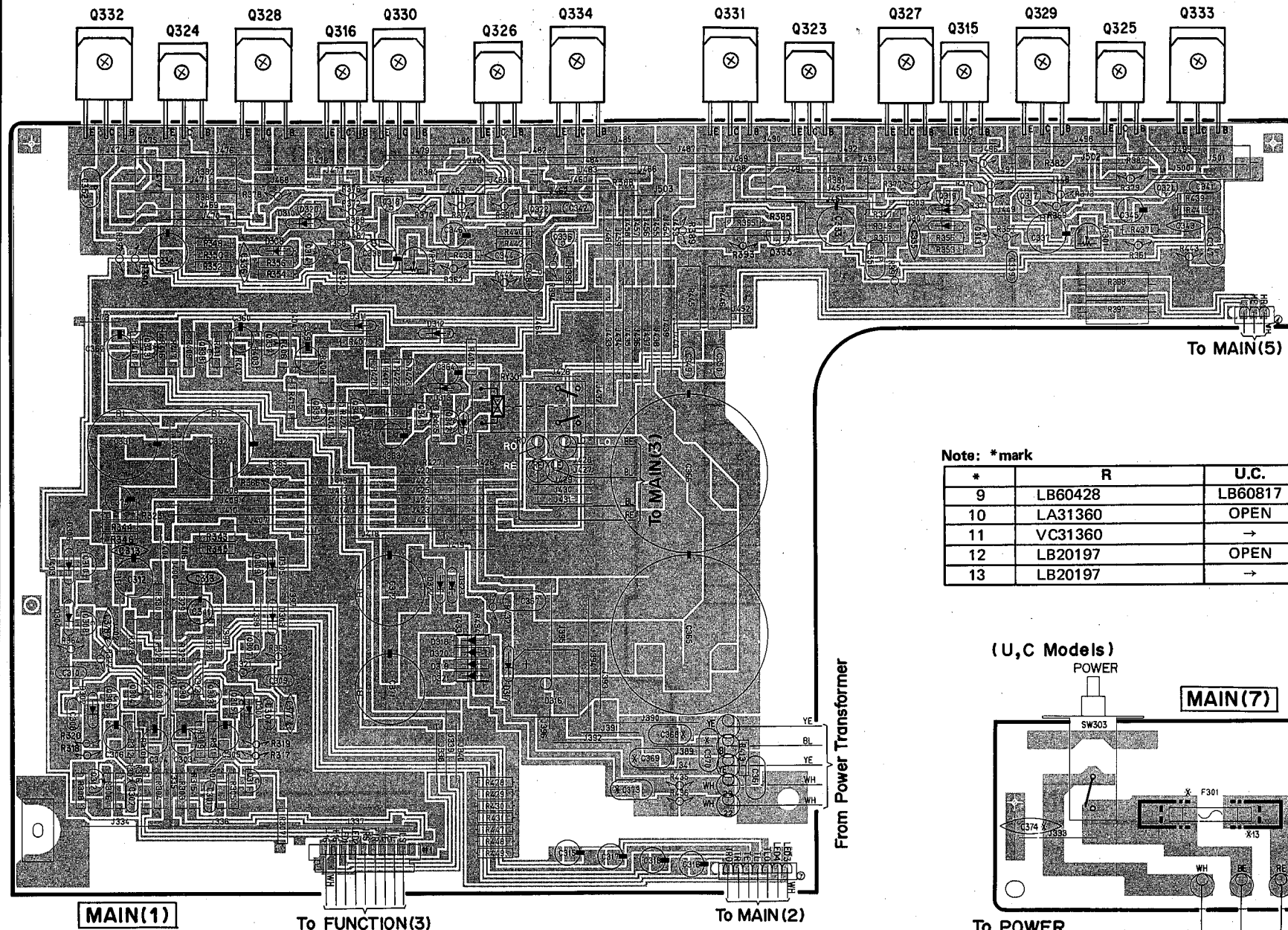

Note: *mark

*	R	U.C.	A	G.B
9	LB60428	LB60817	OPEN	→
10	LA31360	OPEN	→	→
11	VC31360	→	→	VC72080
12	LB20197	OPEN	→	→
13	LB20197	→	LB20106	→

Note: *marked

	R.U.A.C	G.B
C127~138, 145~148	OPEN	220P
R141~156, 175~180, 183, 184	SHORT	220
L101, 102	SHORT	15μH
L103, 104	OPEN	470μH
R105, 106	33	4.7K
C161	OPEN	0.01
C139~144, 162, 163	OPEN	470P
R181	OPEN	4.7
C101, 102	OPEN	150P/100 P
C111, 112	1500P	2200P
R173, 174	SHORT	22
J129	OPEN	SHORT

Note: *marked

	R	U.C	A	G.B
C361, 368, 369, 373	OPEN	→	0.1/250	→
C370	0.1/250	→	OPEN	→
C353~358	OPEN	→	0.01	→
C377, 378	OPEN	→	150P	→
R401, 402, 413	OPEN	→	10	→
F301	10A250V	→	T4A250V	→
F302	T5A250V	OPEN	→	→
C374	-	-	-	○

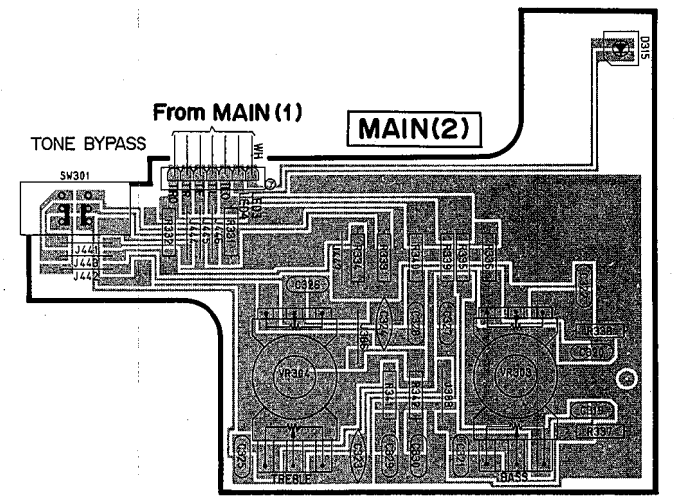

(R Model)
POWER

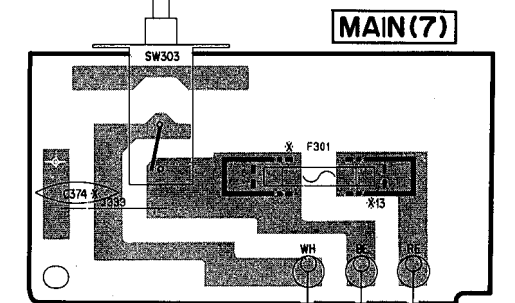

MAIN(7)

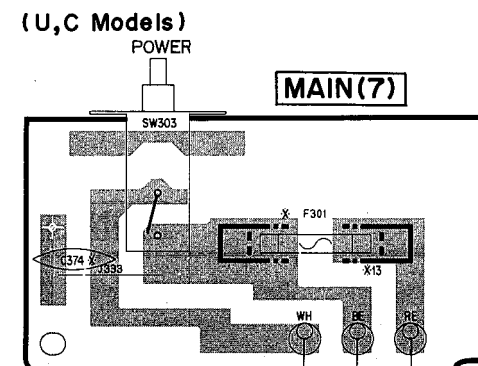

(U,C Models)
POWER
MAIN(7)
MAIN(6)

To MAIN(2)
To POWER TRANSFORMER

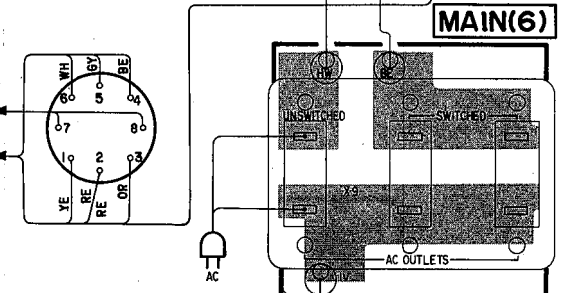

MAIN(6)

To POWER TRANSFORMER
(A, G, B Models)
POWER

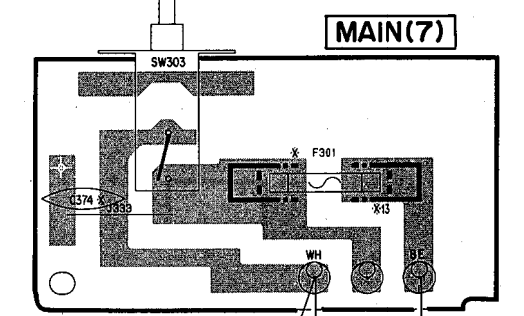

MAIN(7)

To POWER TRANSFORMER
(A) (G, B)

To POWER TRANSFORMER

From AC CORD
To POWER TRANSFORMER

AX-700/700U

PRINTED CIRCUIT BOARD (Pattern Side) (Note) 文字面 : Component Side

1
2
3
4
5
6
7

MAIN(5)

From MAIN(1)

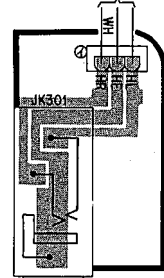

PHONES

MAIN(3)

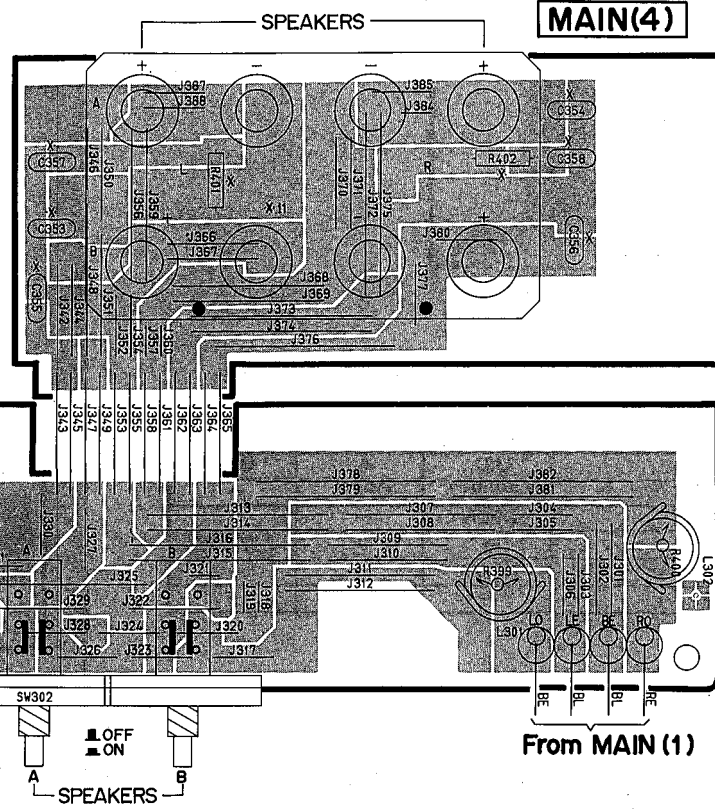
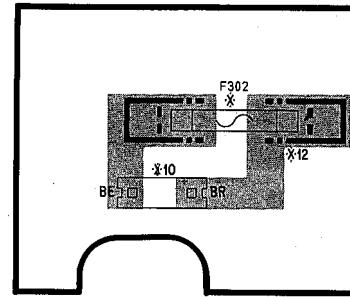

From MAIN(1)

FUNCTION(3)

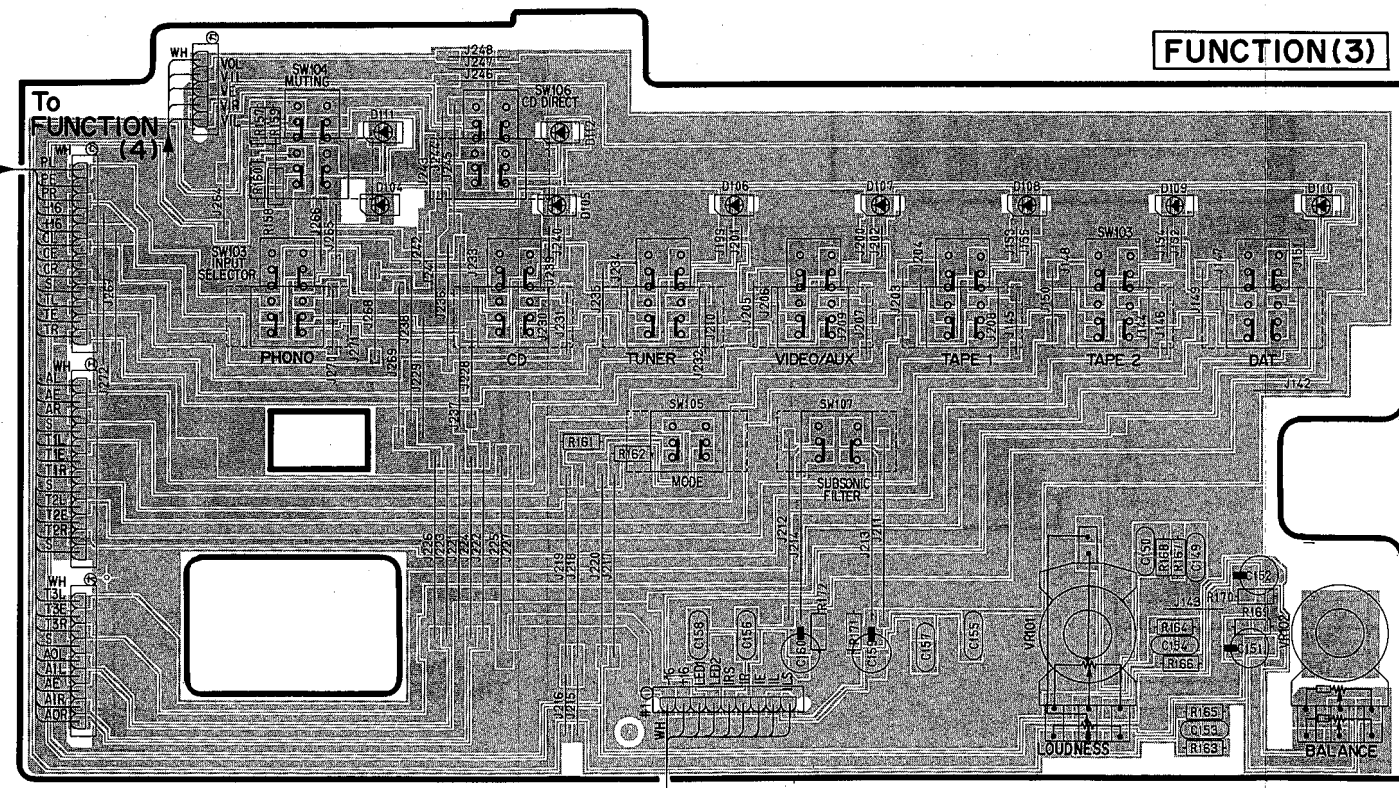

From FUNCTION(2)

To FUNCTION(4)

From MAIN(1)

Note: *marked

*	R.U.A.C	G.B.
1	J101	R141
2	J102	R142
3	J103	R143
4	J104	R144
5	J105	R145
6	J106	R146
7	J107	R147
8	J108	R148
9	J109	R149
10	J110	R150
11	J111	R151
12	J112	R152
13	J113	R153
14	J114	R154
15	J115	R155
16	J116	R156
17	J125	L102
18	J126	L101
19	J117	R173
20	J118	R174
21	J119	R175
22	J120	R176
23	J121	R177
24	J122	R178
25	J123	R179
26	J124	R130
27	J127	R183
28	J128	R184

FUNCTION(4)

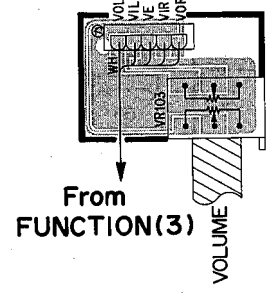

From FUNCTION(3)

VOLUME

FUNCTION(1)

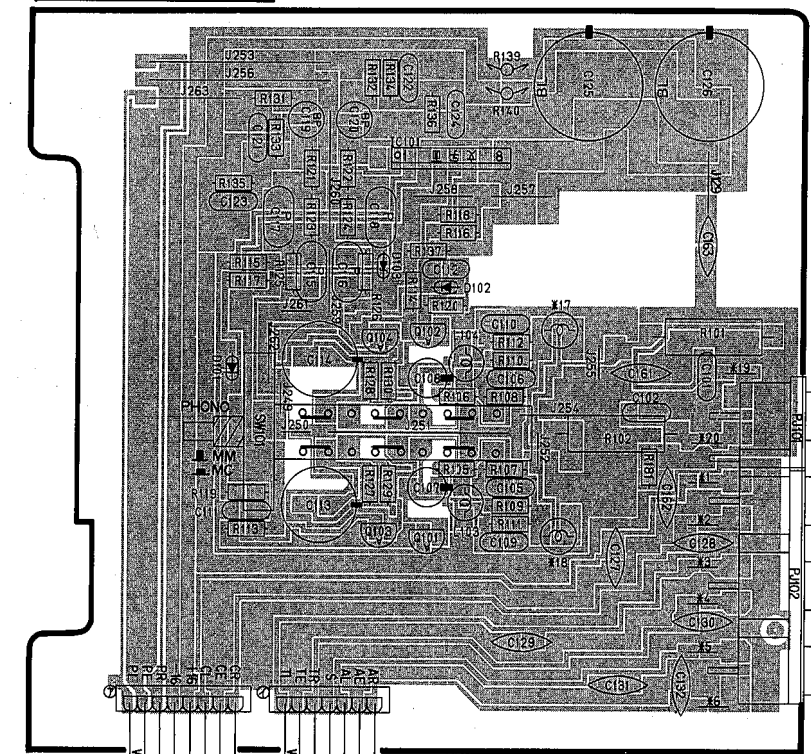

PHONO
CD
TUNER
VIDEO/AUX

FUNCTION(2)

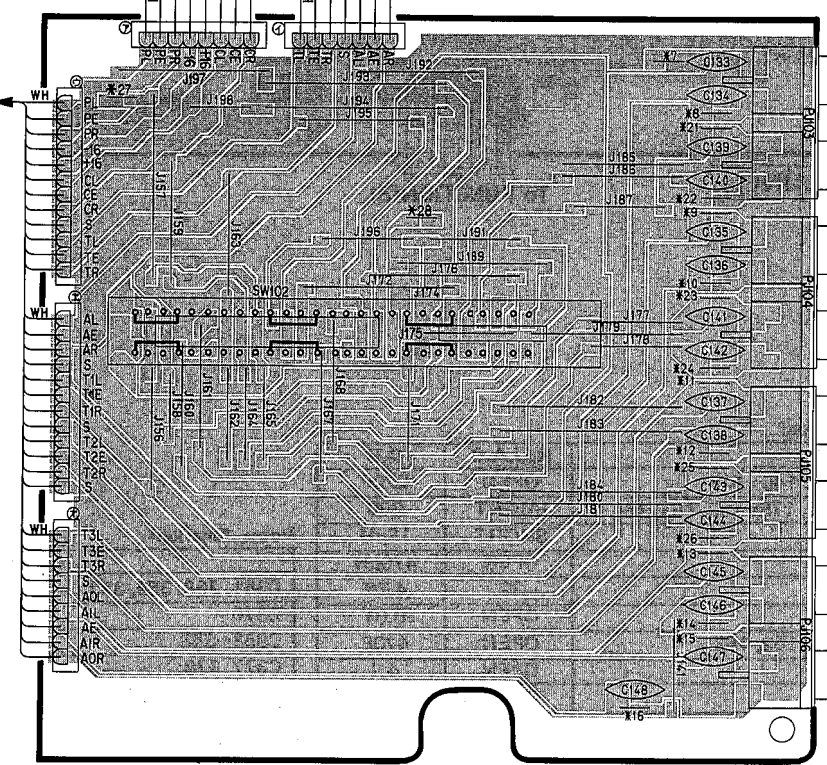

TAPE PB
TAPES 1
REC OUT
TAPE PB
TAPES 2
REC OUT
TAPE PB
DAT
REC OUT
SEND
ACCESSORY
RECEIVE

To FUNCTION(3)

SCHEMATIC DIAGRAM

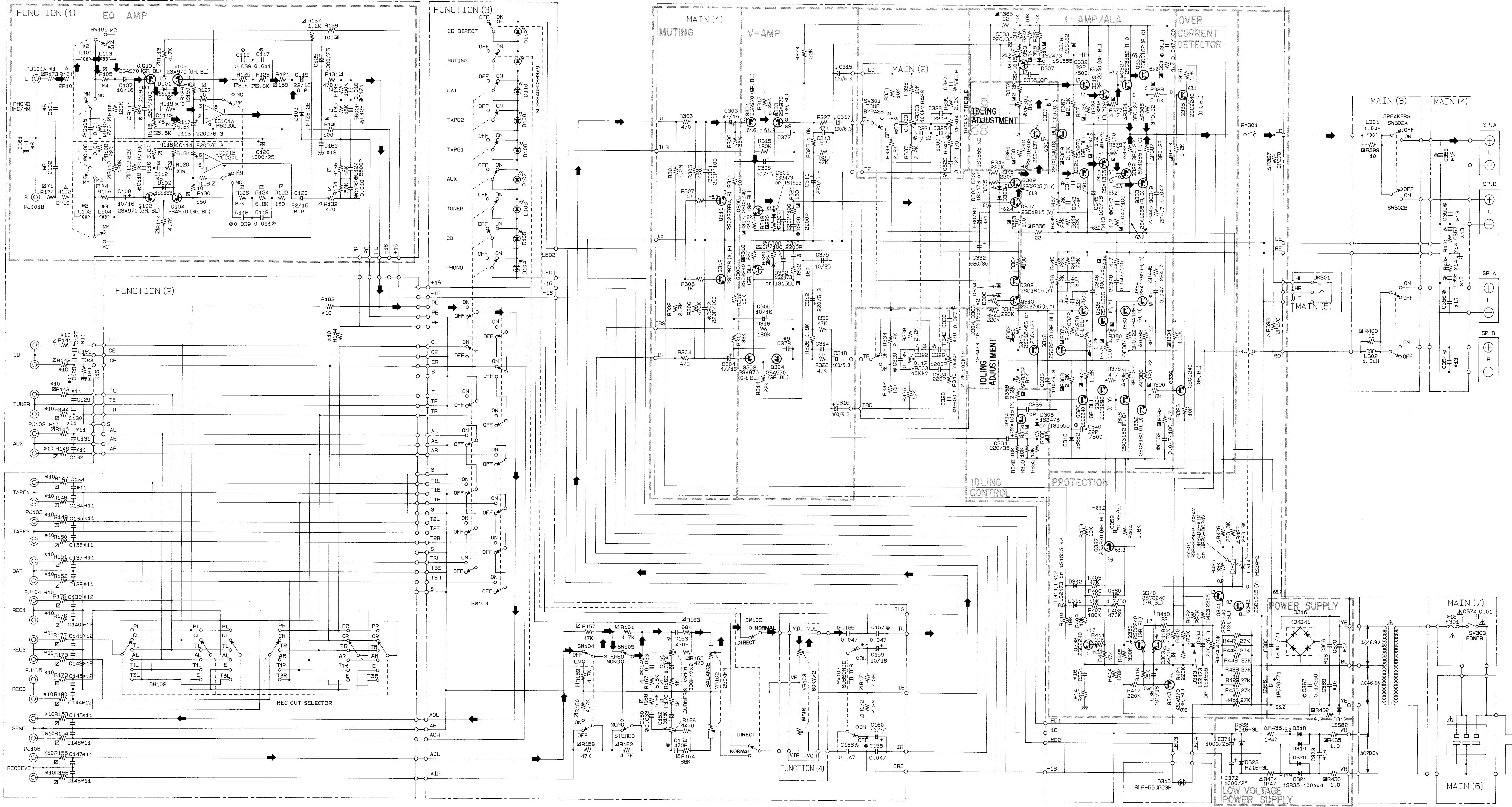

	R	U, C	A	B, G
*1	SHORT			22
*2	SHORT			15 uH
*3	OPEN			470 uH
*4	33			4.7K
*5	@1500P			@2700P
*6	OPEN			@150P/100
*8	OPEN			0.01
*9	OPEN			150P
*10	SHORT			220

	R	U, C	A	B, G
*11	OPEN			220P
*12	OPEN			470P
*13	OPEN			@0.01
*14	OPEN			10
*15	OPEN			4.7
*16	OPEN			0.1/250
*17	0.1/250			OPEN
*18	10A 250V			14.0A 250V
*19	100			180

RESISTOR

REMARKS	PARTS NAME
NO MARK	CARBON FILM RESISTOR
□	CARBON FILM RESISTOR (1/6W)
△	METAL OXIDE FILM RESISTOR
○	METAL FILM RESISTOR
⊠	METAL PLATE RESISTOR
■	FIRE PROOF CARBON FILM RESISTOR
□	SEMENT MOLDED RESISTOR
⊙	SEMI VARIABLE RESISTOR

CAPACITOR

REMARKS	PARTS NAME
NO MARK	ELECTROLYTIC CAPACITOR
NO MARK	CERAMIC CAPACITOR
⊙	POLYESTER FILM CAPACITOR
○	POLYSTYRENE FILM CAPACITOR
⊕	MICA CAPACITOR
⊖	POLYPROPYLENE FILM CAPACITOR
●	SEMICONDUCTIVE CERAMIC CAPACITOR

IC BLOCK

IC101: M5220L (Dual Low-Noise Pre-Amp.)

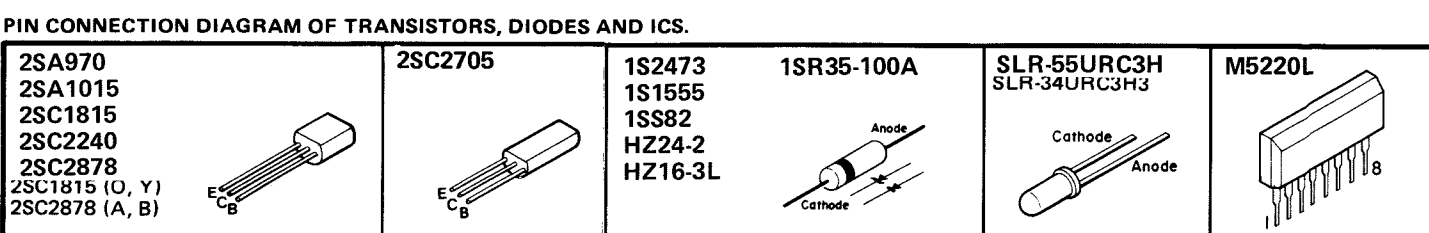

* All voltages are measured with a 10MΩ/DC electric volt meter.
 * Components having special characteristics are marked with a triangle and must be replaced with parts having specifications equal to those originally installed.
 * Schematic diagram is subject to change without notice.